

High resolution multi-lane road surface mapping using 3D laser profilers

**John LAURENT M. Sc. P. Eng., Benoit PETITCLERC, P. Eng., Eric SAMSON, Ph. D.,
Pavemetrics Systems Inc., Canada**

SUMMARY

Road Transportation Ministries and asset managers around the world usually require annual inspections of their roads and infrastructures in order to plan maintenance operations. Road surface defects (texture, cracks, rutting, IRI - smoothness) are important data that need to be measured and serve as input data to PMS (Pavement Management Systems) software. These defects are likely measured using 3D laser sensors that acquire the shape of the road surface in order to evaluate its condition. Once it is determined that the road condition has degraded to the point that it needs to be rehabilitated and resurfaced then a high precision survey of its surface is usually required. This survey is typically used by the engineers as an input to 3D CAD road design software that can then be output to control 3D pavers and millers using laser tracking total stations.

This article proposes a totally new approach that provides a way to tag collected high resolution high accuracy transverse road profile data acquired by a LCMS system (Laser Crack Measuring System - Pavemetrics) combined with a highly accurate GNSS-INS system (Applanix POS-LV - Trimble) to measure both road surface condition and to generate a survey grade accuracy terrain map of any road surface.

This article will describe how the information provided by the 3D LCMS system, DMI, Applanix POS-LV, GPS with local RTK corrections and post processing (POSPac-Trimble) software are used to generate the road surface models. The accuracy of the models created are evaluated comparing them to surveyed control points and determining the repeatability measurements of multiple runs.

Results will show that using this method it is possible to generate much higher resolution survey grade road surface models that can be used for resurfacing applications using 3D paving and milling equipment from the original 3D data that was used to evaluate the actual condition of the road surface itself. This process results in significant productivity improvements, optimization of the quantity of material that needs to be carried in and out, lower survey costs, decreased traffic interruptions and improved safety of surveyors while improving the quality and resolution of the road surface models.

High resolution multi-lane road surface mapping using 3D laser profilers

**John LAURENT M. Sc. P. Eng., Benoit PETITCLERC, P. Eng., Eric SAMSON, Ph. D.,
Pavemetrics Systems Inc., Canada**

INTRODUCTION

Road transportation ministries and asset managers around the world usually require annual inspections of their roads and infrastructures in order to plan maintenance operations. Road surface defects (texture, cracks, rutting, IRI – smoothness) are important data that need to be measured and serve as input data to PMS (Pavement Management Systems) software. These defects are likely measured using 3D laser sensors that acquire the shape of the road surface in order to evaluate its condition [1] [2] [3] [4] [5] [6]. Once it is determined that the road condition has degraded to the point that it needs to be rehabilitated and resurfaced then a high precision survey of its surface is usually required. This survey is typically used by the engineers as an input to 3D CAD road design software that can then be output to control 3D pavers and millers using laser tracking total stations.

Until now, the only way to capture a highly accurate representation of the road surface was to mandate surveyors with laser total stations to sample each lane over the entire length of the project. This action requires a lot of human resources and necessitates the closure of lanes to traffic.

The approach that we propose is to combine data from different sensors (3D laser profilers, inertial system, GNSS and DMI) to produce a real 3D representation of the road surface that is as accurate as the one produced by a surveyor but with a higher density of data.

1. SYSTEM CONFIGURATION

The 3D mapping solution proposed is based on data provided by 2 laser profilers that acquire 4000 point 3D transverse profiles of a road lane up to 4m wide. These sensors can operate at profile rates as high as 28,000Hz allowing the acquisition of a transverse profile at 1mm intervals at speeds up to 100km/h. These 3D point clouds are usually processed to extract road surface distresses such as cracks, ruts, pot holes and even evaluate aggregate loss and surface texture.

To acquire real 3D surface maps of the road the 3D data from the laser profilers must be corrected to compensate for vehicle and suspension motion, driver wander and vibrations. To achieve this a Distance Measuring Instrument (DMI) and sensors capable to provide inertial information about the attitude of the vehicle/sensors installation and its location must be added to the system. To achieve this a Global Navigation Satellite System (GNSS) and an Inertial

Measurement Unit (IMU) or an Inertial Navigation System (INS) that integrates both functions must be added to the system.



Figure 1: Photo of the 3D laser profilers (LCMS) and INS system on the survey vehicle.



Figure 2: Photo of the 3D laser profilers (LCMS) and INS system on the survey vehicle.

2. SYSTEM CALIBRATION

System calibration is required to map the different physical locations and coordinate systems of the systems components (GPS, IMU, Laser Sensor, DMI) on the survey vehicle into a single final reference system (GPS). The purpose of the calibration is to establish the digital model of the position of 3D sensors on the vehicle versus the position of the other elements (GPS, IMU, DMI).

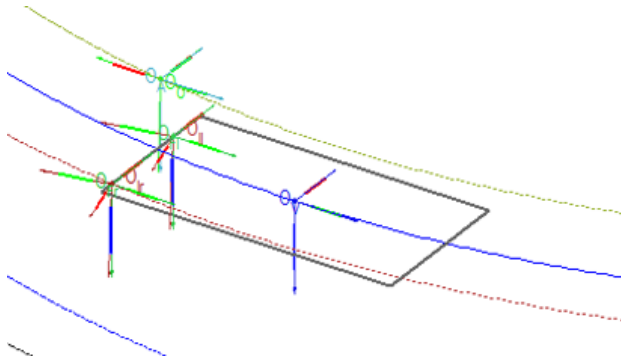

Figure 3 : 3D representation of the numerical model.

The calibration process consists in four steps.

2.1 Physical measures of the different level arms between each system sensors.

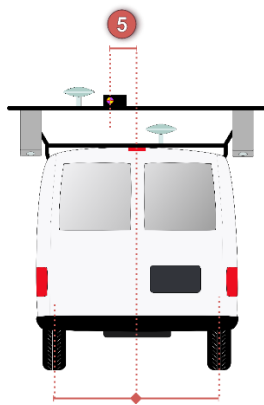

Figure 4: Distance measurements between components.

2.2 Scan of a reference surface



Figure 5: Scan of the calibration object.

That step of the calibration process establishes the necessary parameters to solve the ambiguity between the left and right LCMS sensors. The overlap zone between the sensors over the reference object will be used as a reference surface and the adjustments done on the different metrics (orientation, angles, height, etc.) of the LCMS sensors to produce a perfect surface will be used in the final calibration solution.

2.3 "Stop And Go"

The "Stop and Go" part of the calibration will measure the acceleration in the 3 axes (X, Y and Z) of the IMU when the vehicle is stationary and when it is accelerating. This information is used to determine the orientation of the sensors related to the gravitational force.

2.4 Calibration runs

3 specific survey type calibration runs are required passing over the reference object and are done to fine tune the calibration parameters (gyro and accelerometer bias) to ensure a perfect match between sensors and runs (Stitching). This step will determine the necessary parameter adjustments required to compensate for the drift over time of the IMUs.

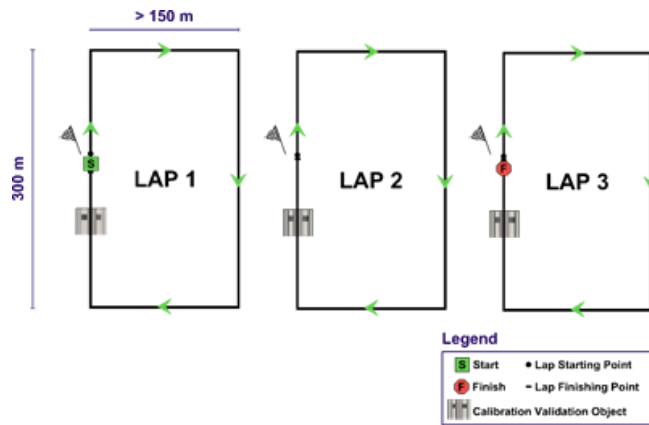

Figure 6: Calibration loops.

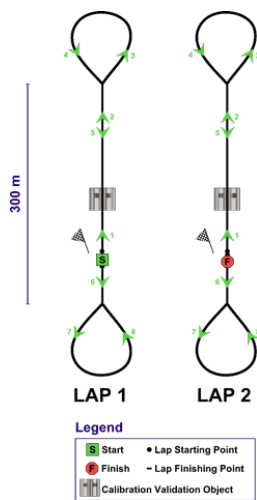

Figure 7: Calibration Back Thru loops.

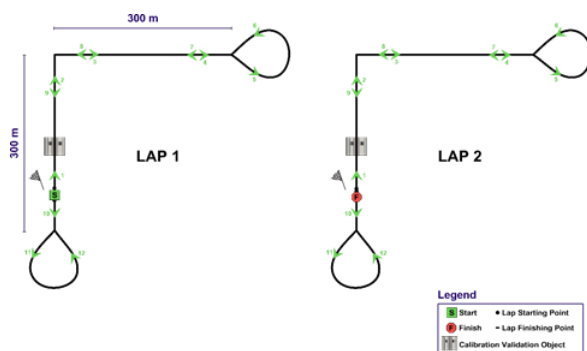

Figure 8: Calibration Right angle loops.

3. PROCESSING

3.1 GNSS/INS systems

To obtain the best accuracy possible, it is highly recommended to post-process the GNSS/INS data using a local base station with RTK corrections.

The GNSS/INS data processing is usually done by the software provided by the INS/GNSS manufacturer. The output of the GNSS/INS post-processing will be fed into the Terrain Mapping software and will replace the real-time navigation solution recorded during the survey.

Even if there is no post-process data available, it is always possible to produce a 3D surface using the real-time data recorded in the files during the data acquisition however accuracy and repeatability will be affected.

3.2 Terrain Mapping

The terrain mapping processing consist on the assignation of an accurate location (Lat/Long, UTM) to each pixels of every profile contained in the LCMS survey.

Three steps are necessary:

3.2.1 Navigation solution (Post-processed or not)

The navigation solution provides all the information on the attitude and movements of the vehicle. This information can be applied through the calibration parameters to the LCMS data.

At this step, the resulting surface is as precise as the navigation solution. The accuracy of the surface can be improved by the usage of alignment and control points as described in the following steps.

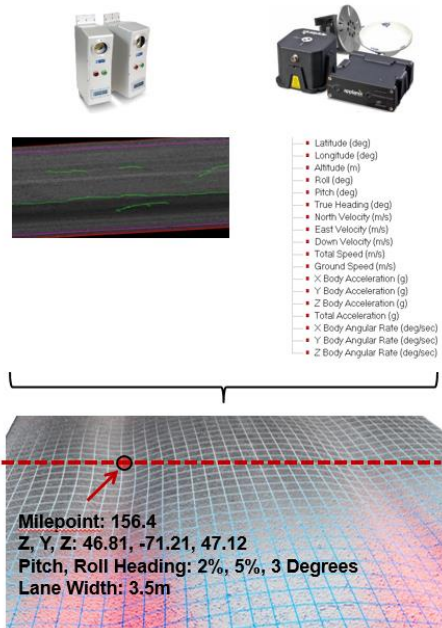

Figure 9: Location system components.

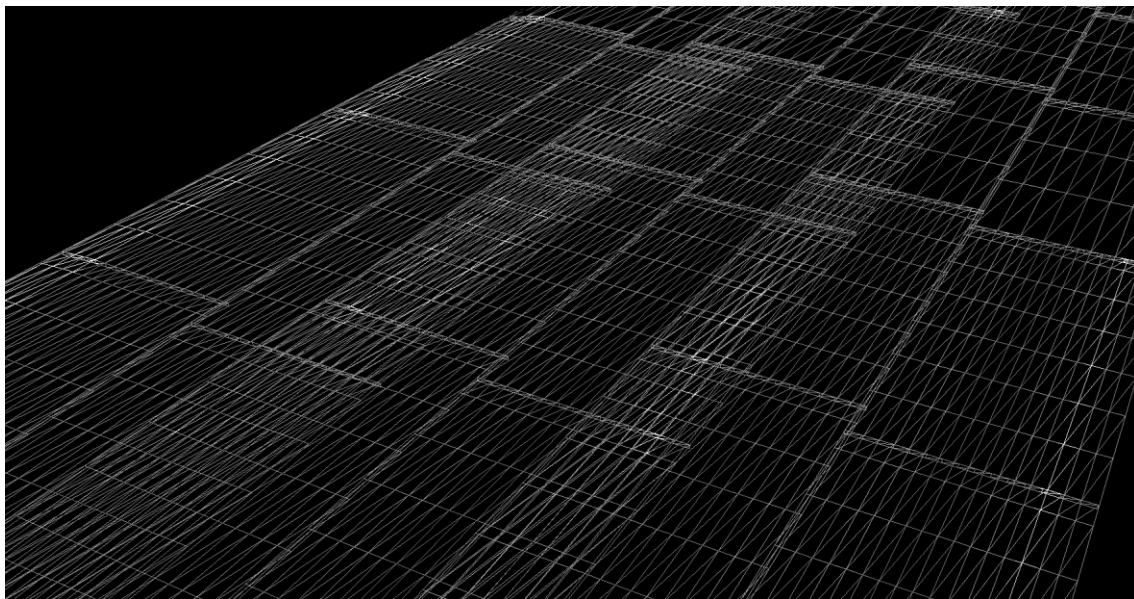

Figure 10: Uncorrected 3D mesh data of three different lane scans (the overlapping areas do not match up well).

3.2.2 Tie points

To perfectly stitch together many lanes coming from many runs or surveys, tie points need to be created in the overlap zone between these lanes.

Tie points are common features that are present in 2 different runs. These points are used to stitch runs all together and to produce a unique surface or point cloud.

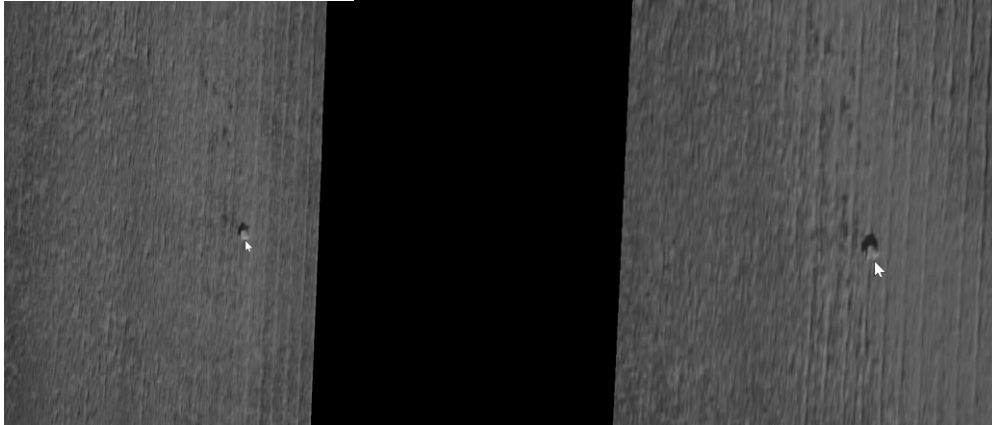

Figure 11: Tie point example.

These points can be found automatically by the detection software using 3D correlation of the overlap zone.

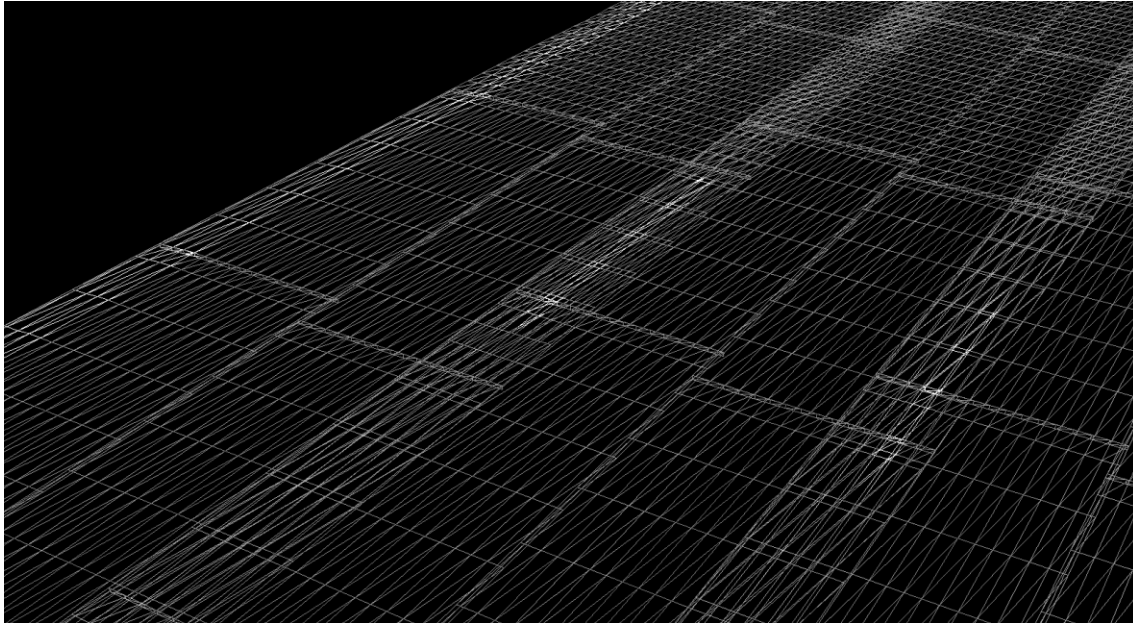

Figure 12: Stitched surfaces.

3.2.3 Applying surveyed reference Alignment points

The alignment points are used to attach the surface to a highly accurate reference point. These points are normally surveyed using a robotic total station and are separated from each other of about 300 to 1000 meters on road surface or shoulder.

These points are then imported in the processing software to be added to the positioning solution.

After that step, the entire point cloud is as accurate as a survey grade survey which means 3 to 5 mm.

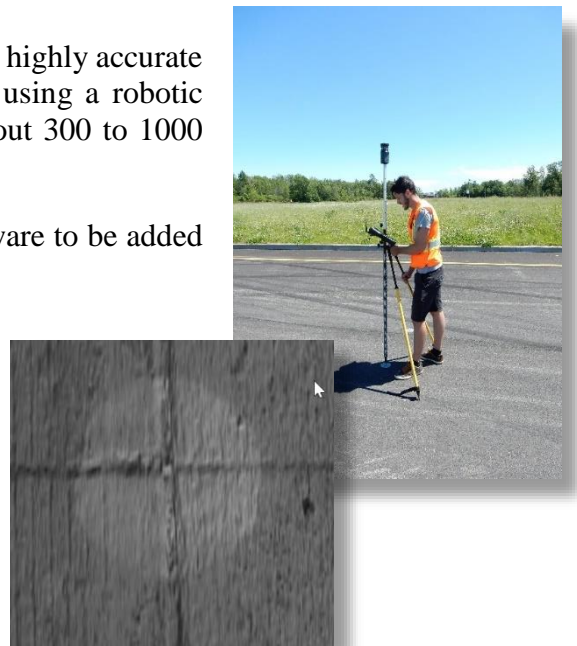

Figure 13: Reference points survey.

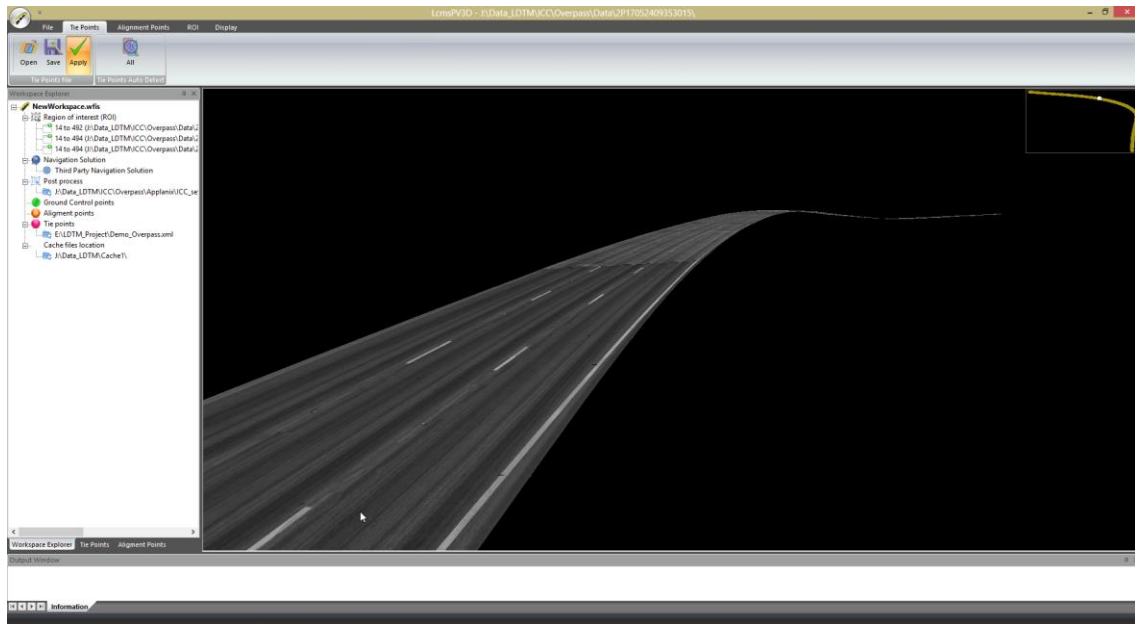

Figure 14: Final result of each of the steps merging three different lanes of a road and bridge deck.

4. RESULT/VALIDATION

In order to establish the accuracy of the system, a reference site was build and more than 500 reference points.

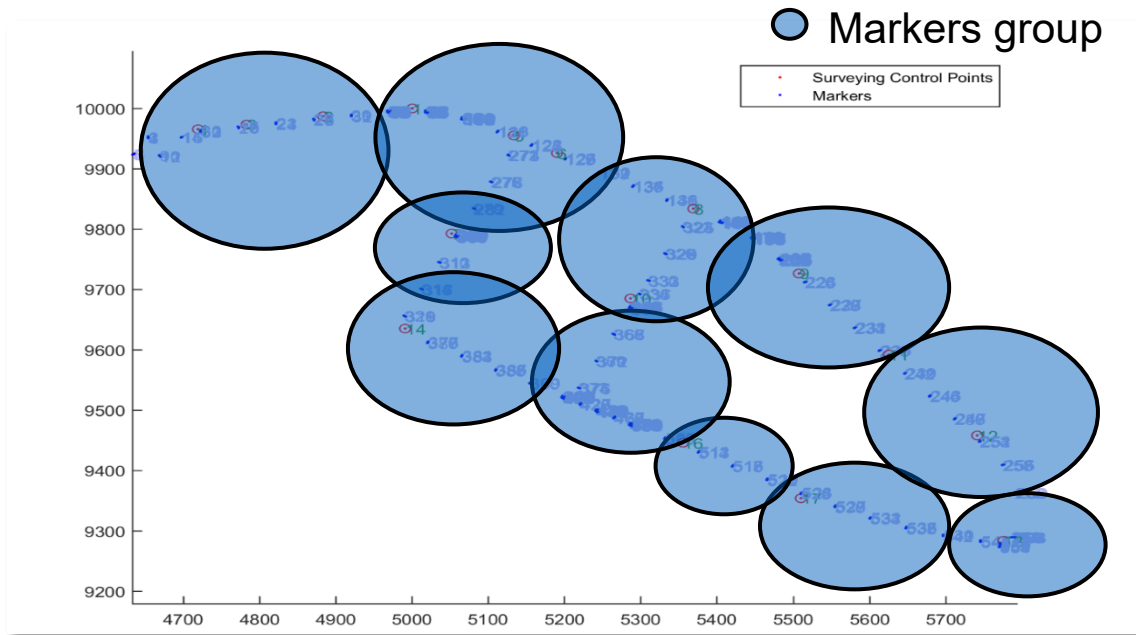

Figure 15: Reference site.

These 500 points were surveyed 3 times using a robotic total station and a laser level. The accuracy of the ground truth which was established to be between 2 and 5 mm.

The Laser Digital Terrain Mapping (LDTM) system (LCMS + POS LV) was then evaluated on the basis of the ground truth and 12 runs were done to evaluate the repeatability and the accuracy of the system.

Two alignment points distances were tested and evaluated, 300 and 850 meters.

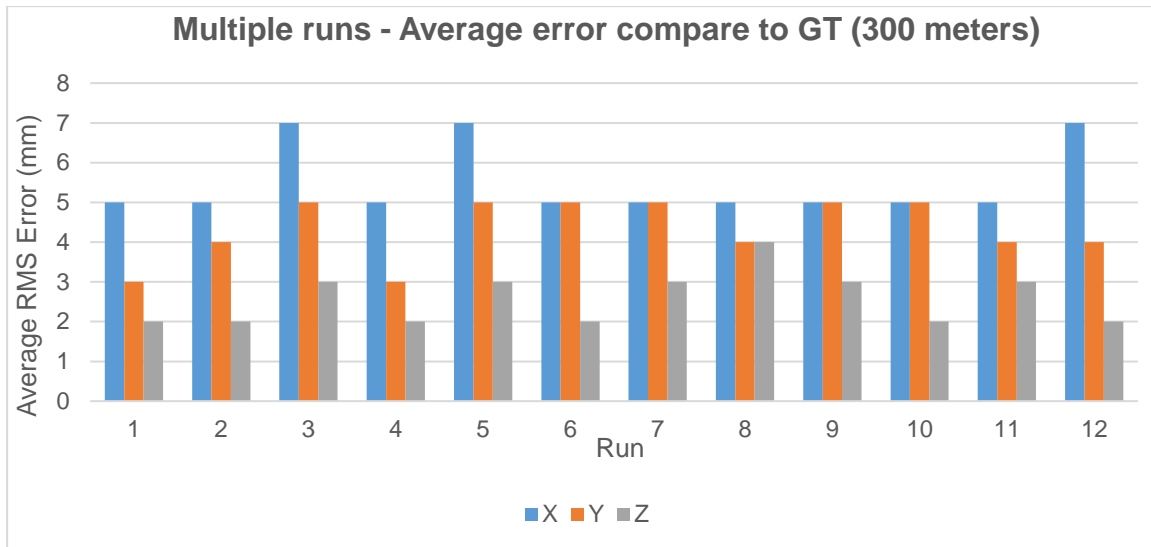

Figure 16: Accuracy LDTM vs GT (300 meters).

Accuracy compare to GT (Avg. in mm):	X: 5.0	Y: 4.0	Z: 2.5
Repeatability compare to first scan (mm)*:	X: 3.0	Y: 5.0	Z: 2.0

The results show that with a distance of 300 meters between the alignment points (control) that the accuracy and the repeatability of the LDTM system were averaging between 2 and 5mm. For the 825 meters scenario, the results showed an overall accuracy of 5 to 9 mm and for the repeatability 4 to 6 mm.

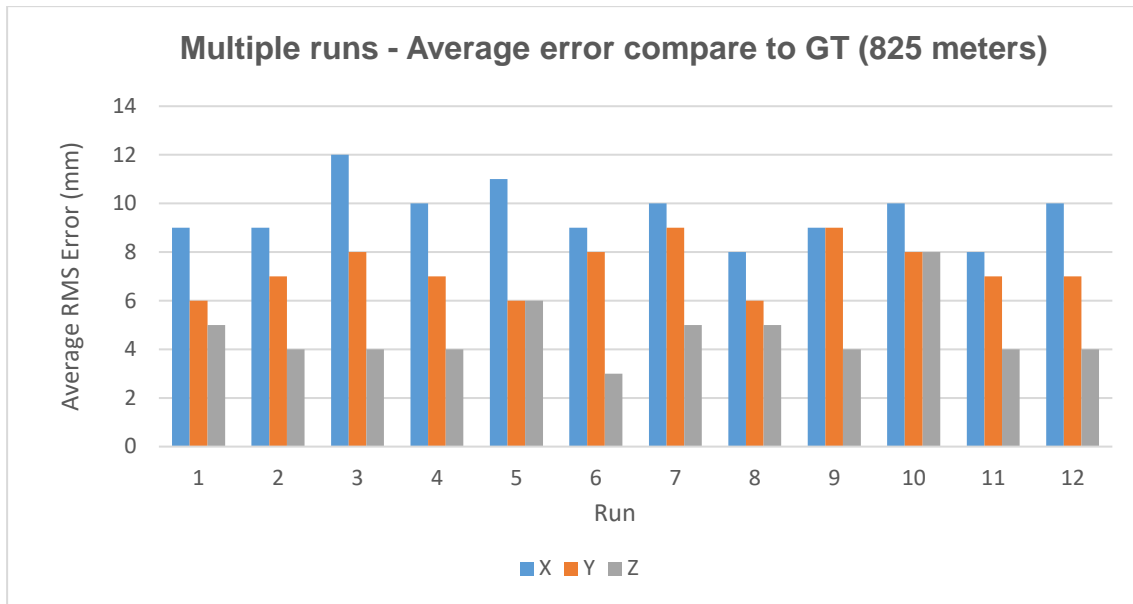

Figure 17: Accuracy LDTM vs GT (825 meters).

Accuracy compare to GT (Avg. in mm): X: 9.0 Y: 7.0 Z: 5.0
 Repeatability compare to first scan (mm)*: X: 6.0 Y: 6.0 Z: 4.0

5. APPLICATION

The Terrain Mapping (LDTM) system can export the surface model data in LAS format that can be read by any 3D CAD software. Before exporting the software will scale the resolution of the data to lower and more manageable point densities. Very nice detailed maps can be generated at resolutions of 100 x 100mm. Points are decimated to fixed resolutions (x,y) and the vertical (z) position is filtered to avoid reporting rocks and cracks on the road surface.

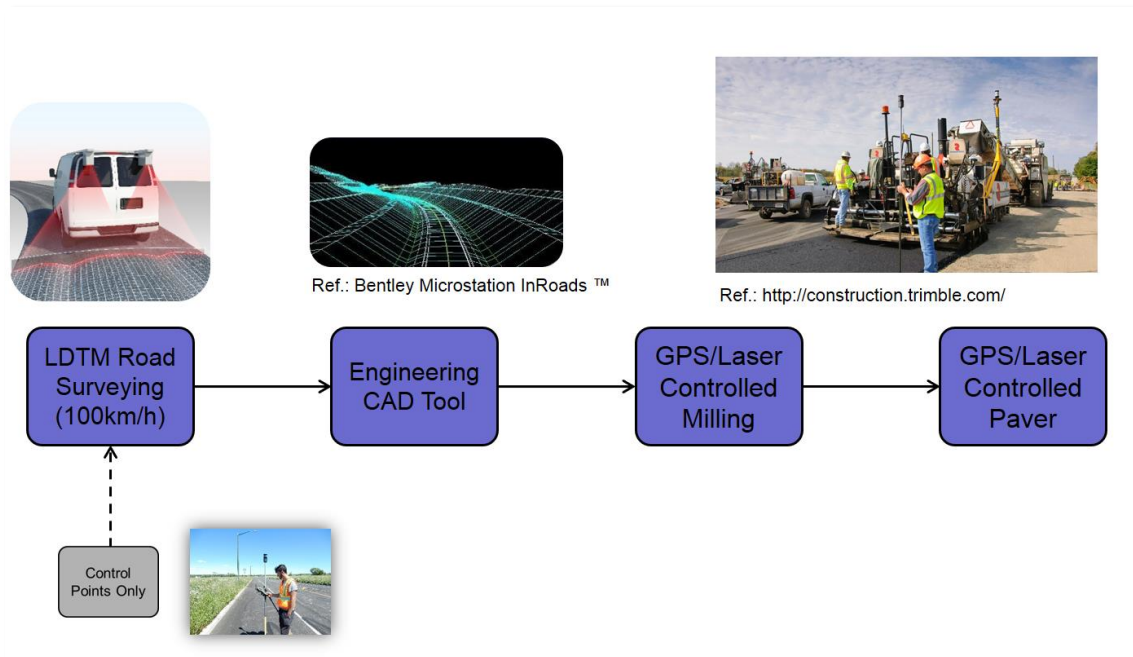

Figure 18: Steps for 3D paving and milling.

These high-resolution 3D surface models can be used by engineers to design better roads [7] [8] [9] compared to the traditional survey method that only generates 3 points across the road every 20m or lidar based mobile mapping solutions that are only accurate to a few centimeters.

This increased resolution allows to better optimize the quantity of material that needs to be carried in and out of the construction site. The use of LDTM models and automated laser controlled milling machines that adjust the height of the cutting heads can be used to correct the roads longitudinal profile (compared to fixed milling depth and 3D controlled Pavers can then be used to create variable thickness new asphalt layers also resulting in a smoother road profiles that will last longer considering the reduced axial dynamic loads resulting from the heavy vehicles.

CONCLUSION

A method was described that combines data from different sensors (3D laser profilers, inertial system, GNSS and DMI) to produce at traffic speed a real 3D representation of the scanned surface. Multiple lanes of a road surface were scanned one at a time and merged automatically together using 3D features detected in common overlapping areas between the scans of adjacent lanes. The resultant road surface map was adjusted to ground control points and the accuracy and repeatability of the overall surface model was evaluated to be as good as those that can be produced by a surveyor with a laser total station.

Using this methodology, it was shown that it is possible to generate much higher resolution survey grade road surface models that can be used for resurfacing applications using 3D paving and milling equipment from the original 3D data that was used to evaluate the actual condition of the road surface itself. This process results in significant productivity improvements from lower survey costs, decreased traffic interruptions and improved safety of surveyors while improving the quality and resolution of the road surface models.

REFERENCES

- [1] Laurent, J., Lefebvre, D., Samson E. (2008). Development of a New 3D Transverse Profiling System for the Automatic Measurement of Road Cracks. Proceedings of the 6th Symposium on Pavement Surface Characteristics, Portoroz, Slovenia.
- [3] Wang, K. C. P. Automated Survey of Pavement Distress Based on 2D and 3D Laser Images. Mack-Blackwell Transportation Center, University of Arkansas, Fayetteville, 2011.
- [4] Li, Q., Y. Ming, Y. Xun, and B. Xu. A Real-Time 3D Scanning System for Pavement Distortion Inspection. Measurement Science and Technology, Vol. 21, No. 1, 2010, p. 015702.
- [5] Wix, R & Leschinski, August 2013, '3D TECHNOLOGY FOR MANAGING PAVEMENTS', Institute of Public Works Engineering Australia conference , Darwin, Australia
- [6] J. Laurent, J-F. Hébert, M. Talbot, 2017, 'Using full lane 1mm resolution 3d road survey data for the automated detection of surface characteristics and geometry.', Baltic Road Conference, Tallinn, Estonia.
- [7] Pekka KilPelainen, Mika Jaakkola, Pauli Alanaatu, 'Development of a control system for a multipurpose road repairing machine', Automation in Construction, Volume 20, Issue 6, October 2011, Pages 662-668.
- [8] Gunnar Gräfe, Kinematic 3D Laser Scanning for Road or Railway Construction Surveys, 1st International Conference on Machine Control & Guidance 2008

[9] Gunnar Gräfe, G., 2005. Kinematic Determination of digital Road Surface Models. Conference on Optical 3D Measurement Techniques VII, Proceedings published by Grün and Kahmen, Vienna, Austria, pp. 21-30.

CONTACTS

John Laurent M. Sc. P. Eng.

Pavemetrics Systems Inc.

150 Boulevard René-Lévesque Est, Suite 1820

Quebec City, PQ

CANADA

G1R 5B1

Tel. +1 418 262 8707

Email: jlaurent@pavemetrics.com

Web site: www.pavemetrics.com

High Resolution Multi-Lane Road Surface Mapping Using 3D Laser Profilers (9334)

John Laurent, Benoit Petitclerc and Eric Samson (Canada)

FIG Congress 2018

Embracing our smart world where the continents connect: enhancing the geospatial maturity of societies

Istanbul, Turkey, May 6–11, 2018